



RICOH COMPANY, LTD.

15-5, Minami Aoyama 1-chome,
Minato-ku, Tokyo 107-8544, Japan
Phone: +81-(0)3-3479-3111

RICOH

Aficio™ AP4510
Setup Guide

Aficio™ AP4510

Setup Guide

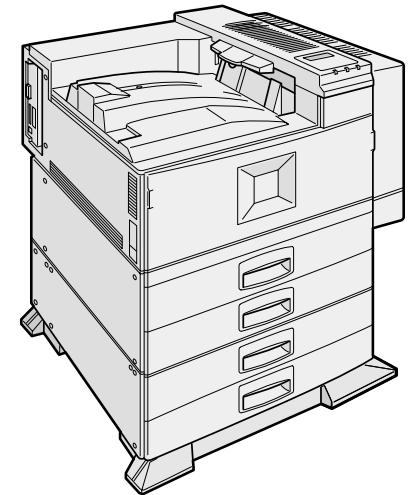

Overseas Affiliates

U.S.A.

RICOH CORPORATION
5 Dedrick Place
West Caldwell, New Jersey 07006
Phone: +1-973-882-2000

The Netherlands

RICOH EUROPE B.V.
Groenelaan 3, 1186 AA, Amstelveen
Phone: +31-(0)20-5474111

United Kingdom

RICOH UK LTD.
Ricoh House,
1 Plane Tree Crescent, Feltham,
Middlesex, TW13 7HG
Phone: +44-(0)20-8261-4000

Germany

RICOH DEUTSCHLAND GmbH
Mergenthalerallee 38-40,
65760 Eschborn
Phone: +49-(0)6196-9060

France

RICOH FRANCE S.A.
383, Avenue du Général de Gaulle
BP 307-92143 Clamart Cedex
Phone: +33-(0)-821-01-74-26

Spain

RICOH ESPAÑA S.A.
Avda. Litoral Mar, 12-14,
08005 Barcelona
Phone: +34-(0)93-295-7600

Italy

RICOH ITALIA SpA
Via della Metallurgia 12,
37139 Verona
Phone: +39-045-8181500

Hong Kong

RICOH HONG KONG LTD.
21/F., Tai Yau Building,
181, Johnston Road,
Wan Chai, Hong Kong
Phone: +852-2862-2888

Singapore

RICOH ASIA PACIFIC PTE.LTD.
260 Orchard Road,
#15-01/02 The Heeren,
Singapore 238855
Phone: +65-830-5888

Model number: RICOH Aficio AP4510

Printed in The Netherlands

EE (GB) G065-8620

For safety, please read this manual carefully before you use this product and keep it handy for future reference.

Introduction

This manual contains detailed instructions on the operation and maintenance of this machine. To get maximum versatility from this machine all operators should carefully read and follow the instructions in this manual. Please keep this manual in a handy place near the machine.

Please read the Safety Information before using this machine. It contains important information related to USER SAFETY and PREVENTING EQUIPMENT PROBLEMS.

Power Source

Aficio AP4510: 220 - 240 V, 50/60 Hz, 8 A or more

Please be sure to connect the power cord to a power source as shown above.

Two kinds of size notation are employed in this manual. With this machine refer to the metric version.

Operator Safety:

This printer is considered a class 1 laser device, safe for office/ EDP use. The printer contains 5-milliwatt, 760 - 800 nanometer wavelength, GaAlAs laser diodes. Direct (or indirect reflected) eye contact with the laser beam might cause serious eye damage. Safety precautions and interlock mechanisms have been designed to prevent any possible laser beam exposure to the operator.

The following label is attached on the back of the printer.



Laser Safety:

The optical housing unit can only be repaired in a factory or at a location with the requisite equipment. The laser subsystem is replaceable in the field by a qualified Customer Engineer. The laser chassis is not repairable in the field. Customer engineers are therefore directed to return all chassis and laser subsystems to the factory or service depot when replacement of the optical subsystem is required.

Important

Contents of this manual are subject to change without prior notice. In no event will the company be liable for direct, indirect, special, incidental, or consequential damages as a result of handling or operating the machine.

Caution:

Use of controls or adjustment or performance of procedures other than those specified in this manual might result in hazardous radiation exposure.

Do not attempt any maintenance or troubleshooting other than that mentioned in this manual. This printer contains a laser beam generator and direct exposure to laser beams can cause permanent eye damage.

For good image quality, Ricoh recommends that you use genuine Ricoh toner.

Ricoh shall not be responsible for any damage or expense that might result from the use of parts other than genuine Ricoh parts with your Ricoh office products.



Declaration of Conformity

"The Product complies with the requirements of the EMC Directive 89/336/EEC and the Low Voltage Directive 73/23/EEC."

Warning

Changes or modifications not expressly approved by the party responsible for compliance could void the user's authority to operate the equipment.

In accordance with IEC 60417, this machine uses the following symbols for the main power switch:

■ means POWER ON.

○ means POWER OFF.

Trademarks

Microsoft, Windows and Windows NT are registered trademarks of Microsoft Corporation in the United States and/or other countries.

Novell, Netware, NDS are registered trademarks or Novell, Inc.

PostScript is a registered trademark of Adobe Systems, Incorporated.

PCL is a registered trademark of Hewlett-Packard Company.

AppleTalk, Apple, Macintosh, TrueType and LaserWriter are registered trademarks of Apple Computer, Incorporated.

IPS-PRINT Printer Language Emulation Copyright© 1999-2000 Oak Technology, Inc., All rights reserved.

Ethernet is a registered trademark of Xerox Corporation.

Other product names used herein are for identification purposes only and might be trademarks of their respective companies. We disclaim any and all rights in those marks.

- The product name of Windows® 95 is Microsoft® Windows® 95.
- The product name of Windows® 98 is Microsoft® Windows® 98.
- The product name of Windows® Me is Microsoft® Windows® Millennium Edition (Windows Me).
- The product names of Windows® 2000 are as follows:
 - Microsoft® Windows® 2000 Advanced Server
 - Microsoft® Windows® 2000 Server
 - Microsoft® Windows® 2000 Professional
- The product names of Windows NT® 4.0 are as follows:
 - Microsoft® Windows NT® Server 4.0
 - Microsoft® Windows NT® Workstation 4.0

Notes:

Some illustrations in this manual might be slightly different from the machine. Certain options might not be available in some countries. For details, please contact your local dealer.

Safety Information

When using your printer, the following safety precautions should always be followed.

Safety During Operation

In this manual, the following important symbols are used:

- | |
|--|
| <p>⚠ WARNING:
<i>Indicates a potentially hazardous situation which, if instructions are not followed, could result in death or serious injury.</i></p> <p>⚠ CAUTION:
<i>Indicates a potentially hazardous situation which, if instructions are not followed, may result in minor or moderate injury or damage to property.</i></p> |
|--|

⚠ WARNING:

- **Connect the power cord directly into a wall outlet and never use an extension cord.**
- **Disconnect the power plug (by pulling the plug, not the cable) if the power cable or plug becomes frayed or otherwise damaged.**
- **To avoid hazardous electric shock or laser radiation exposure, do not remove any covers or screws other than those specified in this manual.**
- **Turn off the power and disconnect the power plug (by pulling the plug, not the cable) if any of the following conditions exists:**
 - **You spill something into the equipment.**
 - **You suspect that your equipment needs service or repair.**
 - **Your equipment's cover has been damaged.**
- **Do not incinerate spilled toner or used toner. Toner dust might ignite when exposed to an open flame.**
- **Disposal should take place at our authorized dealer or at appropriate collection sites.**
- **Dispose of the used toner bottle in accordance with the local regulation.**

⚠ CAUTION:

- *Do not eat or swallow toner.*
- *Keep toner (used or unused) and toner bottle out of the reach of children.*
- *Protect the equipment from dampness or wet weather, such as rain, snow, and so on.*
- *Unplug the power cord from the wall outlet before you move the equipment. While moving the equipment, you should take care that the power cord will not be damaged under the equipment.*
- *When you disconnect the power plug from the wall outlet, always pull the plug (not the cable).*
- *Do not allow paper clips, staples, or other small metallic objects to fall inside the equipment.*
- *For environmental reasons, do not dispose of the equipment or expended supply waste at household waste collection points. Disposal can take place at an authorized dealer or at appropriate collection sites.*
- *The inside of the machine could be very hot. Do not touch the parts with a label indicating "⚠" (means hot surface). Touching "⚠" (means hot surface) could result in a burn.*
- *Our products are engineered to meet high standards of quality and functionality, and we recommend that you only use the expendable supplies available at an authorized dealer.*
- *Do not put an object on the front cover when it is open.*
- *When removing misfed paper, do not touch the fusing section because it becomes very hot.*
- *To prevent an injury, this printer should be lifted by at least two people.*
- *When moving the machine, each person should hold the handles that are located on opposite sides, and then lift it slowly. Lifting it carelessly or dropping it may cause an injury.*
- *Before installing options, the machine should be turned off and unplugged for at least an hour. Components inside the machine become very hot, and can cause a burn if touched.*

ENERGY STAR Program

	<p>As an ENERGY STAR Partner, we have determined that this machine model meets the ENERGY STAR Guidelines for energy efficiency.</p>
---	--

The ENERGY STAR Guidelines intend to establish an international energy-saving system for developing and introducing energy-efficient office equipment to deal with environmental issues, such as global warming.

When a product meets the ENERGY STAR Guidelines for energy efficiency, the Partner shall place the ENERGY STAR logo onto the machine model.

This product was designed to reduce the environmental impact associated with office equipment by means of energy-saving features, such as Low-power mode.

- **Energy Saver mode**

This printer automatically lowers its power consumption 60 seconds after the last operation has been completed. To exit Energy Saver mode, press any key on the control panel. To change the setting of the Energy Saver mode, see “*System Menu*” in the Printer Reference on the CD-ROM labeled “Operating Instructions”.

- ◆ **Specifications**

Energy Saver mode	Power Consumption	9 W or less for Europe and Asia/Pacific 8 W or less for North America
	Default Time	60 seconds

 **Recycled Paper**

In accordance with the ENERGY STAR Program, we recommend use of recycled paper which is environment friendly. Please contact your sales representative for recommended paper.

Manuals for This Printer

Manuals for This Printer

The following manuals describe the operational procedures and maintenance of this machine.

To enhance safe and efficient operation of this printer, all users should read and follow the instructions carefully.

❖ **Quick Installation Guide**

Describes how to install the printer.

❖ **Setup Guide (this manual)**

Provides information about setting up the printer and its options. This manual is provided as a printed manual, and also as a PDF file on the CD-ROM labeled "Operating Instructions".

❖ **Printer Reference**

Provides information about using the printer and its options. This manual is provided as a PDF file on the CD-ROM labeled "Operating Instructions".

❖ **Network Printing Guide**

Provides information about setting up and using the printer in a network environment. This manual is provided as a PDF file on the CD-ROM labeled "Operating Instructions".

❖ **PostScript 3 Operating Instructions Supplement**

Describes the menus and features for the PostScript 3 printer driver. This manual is provided as a PDF file on the CD-ROM labeled "Operating Instructions".

Note

- There are three CD-ROMs that come with this printer. "Operating Instructions", "Printer Drivers and Utilities", and "Document Management Utility".
- Concerning UNIX information, please visit our web site or consult your authorized reseller.

How to Read This Manual

Symbols

In this manual, the following symbols are used:

WARNING:

This symbol indicates a potentially hazardous situation which, if instructions are not followed, could result in death or serious injury.

CAUTION:

This symbol indicates a potentially hazardous situation which, if instructions are not followed, may result in minor or moderate injury or damage to property.

* The statements above are notes for your safety.

Important

If this instruction is not followed, paper might be misfed, originals might be damaged, or data might be lost. Be sure to read this.

Preparation

This symbol indicates the prior knowledge or preparations required before operating.

Note

This symbol indicates precautions for operation, or actions to take after misoperation.

Limitation

This symbol indicates numerical limits, functions that cannot be used together, or conditions in which a particular function cannot be used.

Reference

This symbol indicates a reference.

[]

Keys that appear on the machine's panel display.

Keys and buttons that appear on the computer's display.

[]

Keys built into the machine's control panel.

Keys on the computer's keyboard.

TABLE OF CONTENTS

1. Getting Started

Features of This Printer	1
Printer Drivers for This Printer	3
Software and Utilities Included on the CD-ROM	5
Guide to This Printer	6
Mainframe	6
Control Panel	9

2. Installing Options

Available Options	11
How to Use the Screwdriver	13
Installing Options	14
Installing Memory Unit TypeC	14
Installing Paper Bank PS430	15
Installing Printer Hard Disk Type4510	18
Installing 1394 Interface Unit Type 4510	22

3. Configuring the Printer for the Network

Configuring the Printer for the Network with the Control Panel	31
IEEE 1394 Configuration	34

4. Installing the Printer Driver and Software

Installation Method	37
Quick Install	38
Installing the PCL 6/5e Printer Driver	40
Installing the PCL 6/5e Printer Driver	40
Installing the RPCS Printer Driver	42
Installing the RPCS Printer Driver	42
Installing the PostScript Printer Driver	44
Windows 95/98/Me - Installing the PostScript Printer Driver	44
Windows 2000 - Installing the PostScript Printer Driver	45
Windows NT 4.0 - Installing the PostScript Printer Driver	47
Using Adobe PageMaker Version 6.0 or 6.5	49
Installing the SmartNetMonitor for Client/Admin	50
Installing the Agfa Monotype Font Manager 2000	51
Macintosh	52
Macintosh - Installing the PostScript 3 Printer Driver	52
Setting Up the PPD File	52
Setting Up Options	53
INDEX	54

1. Getting Started

Features of This Printer

This printer is designed especially for office work groups. It can be used for network environments and allows you to handle documents efficiently.

❖ High Performance

The new 45 print per minute (ppm) engine with RM7000A 250 MHz processor and built-in 10 GB Printer Hard Disk (HDD) reduces waiting time for output.

❖ Versatile Paper Handling Options

This printer offers a variety of paper handling options.

The large input capacity, up to 3,550 sheets from six input sources, reduces the inconvenience of reloading paper.

The output devices free users from manually collating, stapling or punching documents.

❖ High Productivity

A high-speed engine combined with advanced paper handling features increases the productivity of users who need to print several sets of multiple page documents.

With the sample printing function, users can confirm that the output is correct before several sets of documents are printed out.

❖ Network Connectivity

This printer is network capable with a built-in 100BASE-TX card.

It is easy to connect this printer to your network with utility.

❖ Crisp Print Image Quality

This printer supports PCL 6 as well as Adobe PostScript 3.

With a real 600dpi-resolution engine (plus smoothing technology), crisp images can be printed. The resolution is 1200 dpi equivalent when the edge smoothing function is used.

◆ Major Specifications

Continuous Printing Speed	45 ppm (A4/letter  , simplex and duplex)
Engine Resolution	300 dpi, 600 dpi
Printer Languages	PCL 5e, PCL 6, RPCS Adobe PostScript 3
Paper Input Capacity	500 sheets × 2 trays + 50 sheets Bypass Tray Max. 3,550 sheets with options
Paper Output Capacity	500 sheets Max. 4,900 sheets with options
Memory	64 MB Expandable to 320 MB
HDD	10 GB or more
Interface	100BASE-TX × 1 IEEE1284 × 1
Options	PS430 (Paper Bank, 500-sheet × 2 trays) Large Capacity Tray RT36 (1500-sheet Large Capacity Tray) Finisher SR720 (1000-sheet finisher) Finisher SR730 (3000-sheet finisher) Mailbox CS360 (9-bin mailbox) Printer Hard Disk Type 4510 (10 GB or more) 1394 Interface Unit Type 4510 Memory Unit Type C 64MB, Memory Unit Type C 128MB, Memory Unit Type C 256MB Barcode Font DIMM Type A Punch Kit Type450 Bridge Unit Type460 Bridge Unit Type1045

Printer Drivers for This Printer

Printing requires installation of a printer driver for your operating system. The following drivers are included on the CD-ROM that comes with this printer.

Printer Language	PCL 6	PCL 5e	RPCS	PostScript3
Operating system				
Windows 95 *1	√	√	√	√ *8
Windows 98 *2	√	√	√	√ *8
Windows Me *3	√	√	√	√ *8
Windows 2000 *4	√	√	√	√ *8
Windows NT 4.0 *5	√	√	√	√ *7 *8
Mac OS *6				√ *8

*1 Microsoft Windows 95 operating system

*2 Microsoft Windows 98 operating system

*3 Microsoft Windows Millennium Edition

*4 Microsoft Windows 2000 Professional

Microsoft Windows 2000 Server

*5 Microsoft Windows NT Server operating system version 4.0, Microsoft Windows NT Workstation operating system version 4.0 in a computer using x86 processors.

*6 Versions 8.6 to 9.1 of the Mac OS can be used. With OS X, the printer operates in Classic Mode.

*7 Requires Service Pack 4 or later.

*8 The Adobe PostScript printer drivers and PostScript Printer Description (PPD) files are included on the CD-ROM labeled "Printer Drivers and Utilities".

◆ PCL printer drivers

Printer drivers allow the computer to communicate with the printer via a printer language. Two kinds of PCL printer drivers, PCL 6 and PCL 5e, are provided with this printer. We recommend PCL 6 as your first choice.

Note

- Some of your applications might require the installation of the PCL 5e printer driver. In this case, you can install PCL 5e in addition to PCL 6.
⇒ p.40 "Installing the PCL 6/5e Printer Driver"

◆ RPCS printer driver

This printer driver allows the computer to communicate with the printer via a printer language.

- ⇒ p.42 "Installing the RPCS Printer Driver"

❖ Adobe PostScript Printer Drivers and PPD files

The Adobe Postscript printer drivers and the PPD files are included on the CD-ROM that comes with this printer. Adobe PostScript printer driver allows the computer to communicate with the printer via a printer language. The PPD files allow the printer driver to enable the printer specific functions.

⇒ p.44 "Windows 95/98/Me - Installing the PostScript Printer Driver"

⇒ p.45 "Windows 2000 - Installing the PostScript Printer Driver"

⇒ p.47 "Windows NT 4.0 - Installing the PostScript Printer Driver"

⇒ p.52 "Macintosh"

Software and Utilities Included on the CD-ROM

There are three CD-ROMs that come with this printer. "Operating Instructions", "Printer Drivers and Utilities" and "Document Management Utility". The following items are included on the CD-ROMs.

❖ **Agfa Font Manager**

Helps you to install new screen fonts, or organize and manage fonts already installed on the system. This manual is provided as a PDF file on the CD-ROM labeled "Printer Drivers and Utilities".

❖ **SmartNetMonitor for Admin**

A utility for the system administrator to manage printers on the network. This manual is provided as a PDF file on the CD-ROM labeled "Printer Drivers and Utilities".

Reference

See SmartNetMonitor for Admin online Help for more information about using SmartNetMonitor for Admin.

❖ **SmartNetMonitor for Client**

A utility for users to manage their own print status on the network. This manual is provided as a PDF file on the CD-ROM labeled "Printer Drivers and Utilities".

Reference

See SmartNetMonitor for Client online Help for more information about using SmartNetMonitor for Client.

❖ **Acrobat Reader**

A utility that allows you to read PDF. This manual is provided as a PDF file on the CD-ROM labeled "Operating Instructions".

Note

- Documentation about using the printer is included on the CD-ROM in PDF format. See Acrobat Reader online Help for more information about using Acrobat Reader.

Important

- If you upgrade to Windows 2000 from Windows 95/98/Me or Windows NT 4.0, the software and utilities must be uninstalled prior to installing Windows 2000. Then reinstall them in a Windows 2000 environment.

Guide to This Printer

1

Mainframe

Exterior: Front View

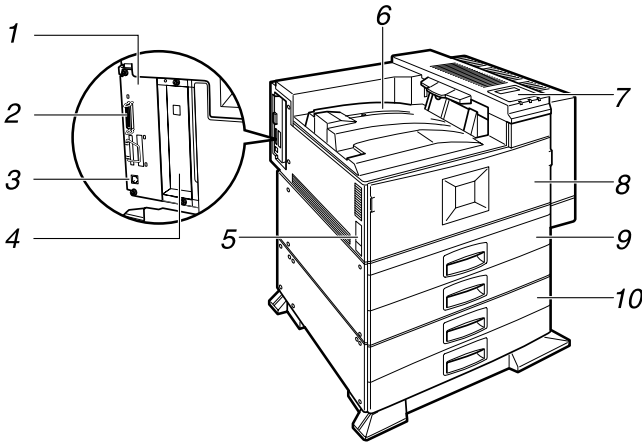

ZFH100J

1. Printer Board

Remove this board when installing some options.

2. Parallel Interface Connector

Plug the parallel cable, which connects the printer to your computer, into this socket.

3. Ethernet Cable Connector

Plug the Ethernet cable, which connects the printer to the network, into this socket.

4. HDD (Option) Slot

Set the optional Printer Hard Disk.
⇒ p.18 "Installing Printer Hard Disk Type4510"

5. Power Switch

Use this switch to turn the printer power on and off.

6. Output Tray

Printed output is stacked here with the print side face down.

7. Control Panel

Contains keys for printing operation and a panel display that shows the printer status.

⇒ p.9 "Control Panel"

8. Front Cover

Open this cover if you replace some parts or if a paper misfeed occurs.

9. Paper Tray

Holds up to 500 sheets of plain paper per tray and 1000 sheets in total. (80 g/m², 20 lb. bond)

10. Paper Bank PS430 (Option)

Holds up to 500 sheets of plain paper per tray and 1000 sheets in total. (80 g/m², 20 lb. bond)

⇒ p.15 "Installing Paper Bank PS430"

Exterior: Rear View

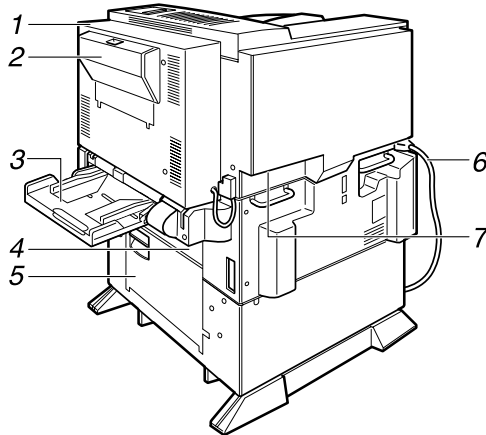

ZFDH180E

1. Duplex Unit

Allows you to print onto both sides of the paper.

2. Duplex Unit Right Cover

Open this cover when accessing the inside of the printer.

3. Bypass Tray

Holds up to 50 sheets of plain paper. (80 g/m², 20 lb. bond)

4. Upper Vertical Paper Feed Cover

Open this cover when accessing the inside of the printer.

If you install the optional Large Capacity Tray RT36, remove this cover.

5. Lower Vertical Paper Feed Cover

Open this cover when accessing the inside of the printer.

6. Power Cord

Plug this cord into a wall outlet.

7. Ventilator

Helps to keep components inside the printer from overheating.

Interior

1

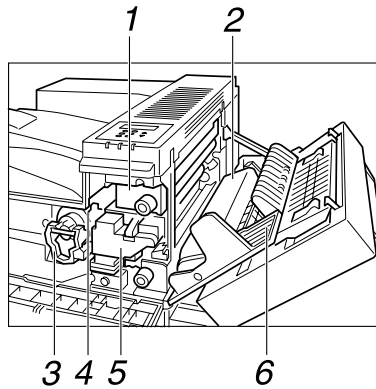

ZFCH190J

1. Fusing Unit

When “Replace Maintenance Kit” appears on the panel display, replace this unit.

2. Transfer Unit

When “Replace Maintenance Kit” appears on the panel display, replace this unit.

3. Toner Lock Handle

Turn up the lever when replacing the toner.

4. Toner Holder

Slide this out when replacing the toner.

5. Development Unit

When “Replace Maintenance Kit” appears on the panel display, replace this unit.

6. Right Cover

Open this cover when accessing the inside of the printer.

Control Panel

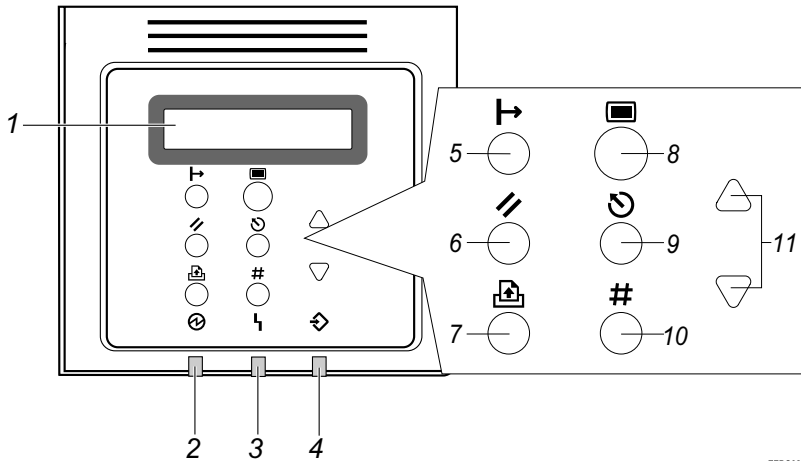

ZFDS022E

1. Panel Display

Shows the current status of the printer and error messages.

See "Error & Status Messages on the Control Panel" in the Printer Reference on the CD-ROM labeled "Operating Instructions".

2. Power Indicator

Is on when the printer power is on.

Is off when the power is off or when the printer is in Energy Saver mode.

3. Error Indicator

Blinks or lights up whenever any printer error occurs. A message describing the cause of the error also appears on the panel display.

See "Error & Status Messages on the Control Panel" in the Printer Reference on the CD-ROM labeled "Operating Instructions".

4. Data In Indicator

Blinks while the printer is receiving data from a computer.

Is on if there is data to be printed.

5. [On Line] Key

Press this key to switch the printer between online and offline.

6. [Job Reset] Key

When the printer is online, press this key to cancel any ongoing print job.

See "Canceling a Print Job" in the Printer Reference on the CD-ROM labeled "Operating Instructions".

7. [Form Feed] Key

If the printer is offline, press this key to print all the data left in the printer's input buffer.

Note

This does not work if the printer is online.

8. [Menu] Key

Press this key to make and check the current printer settings.

See "Making Printer Settings with the Control Panel" in the Printer Reference on the CD-ROM labeled "Operating Instructions".

9. [Escape] Key

Press this key to return to the previous condition on the panel display.

10. [Enter #] Key

Press this key to execute menu items selected on the panel display.

Press this key to clear some errors.

See "*Troubleshooting*" in the Printer Reference on the CD-ROM labeled "Operating Instructions".

11. [▲][▼] Keys

Use these keys to increase or decrease values on the panel display when making settings.

2. Installing Options

⚠ CAUTION:

- Before installing options, the machine should be turned off and unplugged for at least thirty minutes. Components inside the machine become very hot, and can cause a burn if touched.
- Before moving the machine, unplug the power cord from the outlet. If the cord is unplugged abruptly, it could become damaged. Damaged plugs or cords can cause an electrical or fire hazard.
- When lifting the machine, use the grips on both sides. The machine could break or cause an injury if dropped.

See "Specifications" in the Printer Reference to confirm what kind of options are available.

⚡ Important

- Rating voltage of the connector for options: max. DC 24 V.

Available Options

The following options can be installed to your printer.

◆ Exterior

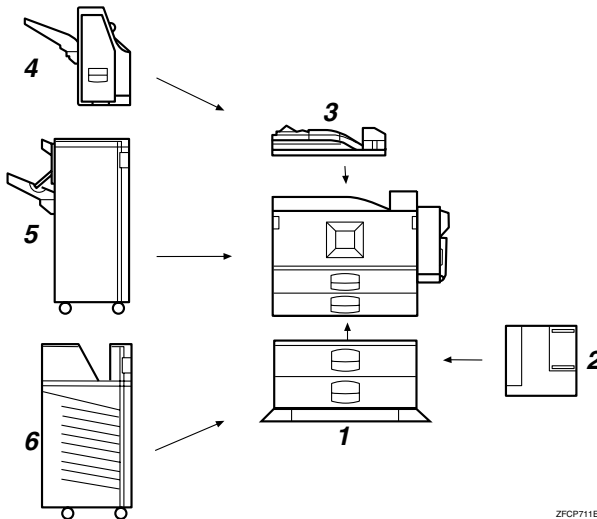

ZFCP711E

1. Paper Bank PS430

⇒ p.15 "Installing Paper Bank PS430"

2. Large Capacity Tray RT36

Holds up to 1500 sheets of plain paper. (80 g/m², 20 lb. bond)

If you want to install the Large Capacity Tray RT36, contact your sales or service representative.

3. Bridge Unit Type1045

This unit is necessary when using the Finisher or the Mailbox.

If you want to install the Bridge Unit Type1045, contact your sales or service representative.

4. Finisher SR720

If you want to install the Finisher SR720, contact your sales or service representative.

◆ Interior

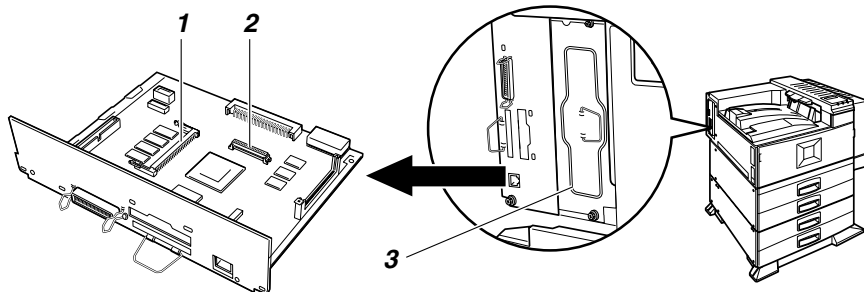

ZF0PT31J

1. Slot for the Memory Unit TypeC

Install the memory unit into the slots in the printer board. There are three types of Memory Unit TypeC, 64 MB, 128 MB and 256 MB. Only one of them can be installed at once. ⇒ p.14 "Installing Memory Unit TypeC"

2. Slot for the 1394 Interface Unit Type 4510

You can perform the print job on the IEEE1394 environment.

⇒ p.22 "Installing 1394 Interface Unit Type 4510"

3. Printer Hard Disk Type4510

Install the HDD into the slot in the printer board.

⇒ p.18 "Installing Printer Hard Disk Type4510"

🔧 Note

- ❑ When you install several different options, be sure to install the Paper Bank PS430 first.

5. Finisher SR730

If you want to install the Finisher SR730, contact your sales or service representative.

6. Mailbox CS360

If you want to install the Mailbox CS360, contact your sales or service representative.

🔧 Note

- ❑ The Bridge Unit Type460 is required when you install both the Finisher SR730 and the Mailbox CS360.
- ❑ To use the punch function with the Finisher SR730, the Punch Kit Type450 is required.

How to Use the Screwdriver

The screwdriver (①) is attached in the standard paper tray (Tray 1). It is used to install options. To easily drive a screw, first place the screw in the screwdriver, and then tighten the screw.

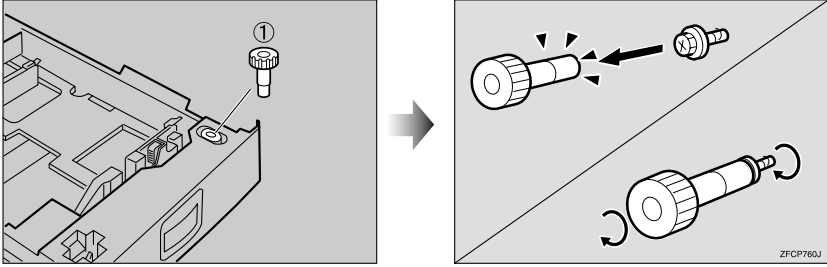

2

Installing Options

Installing Memory Unit TypeC

2

⚠ CAUTION:

- Do not touch the inside of the printer board compartment. It may cause a machine malfunction or a burn.

⚡ Important

- The memory unit can be damaged by a small amount of static electricity. Before touching it, touch some metal to remove static electricity from you.
- When the bidirectional transmission is not in operation, you must set up the installed memory unit using the printer driver in order to use it. See p.37 "Installing the Printer Driver and Software" for setting up options. See p.48 "The conditions of the bidirectional transmissions" for information about bidirectional transmission.

1 Turn off the printer.

2 Pull out the first paper tray (Tray 1) and take the screwdriver (①) from the tray. Each screw to be removed requires this screwdriver.

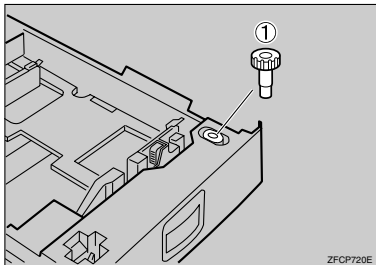

3 Remove the two screws locking the printer board.

The screws are needed to lock the printer board afterwards.

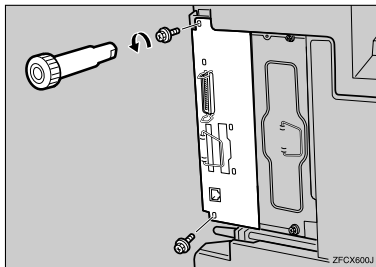

4 Hold the handle, and carefully pull out the printer board.

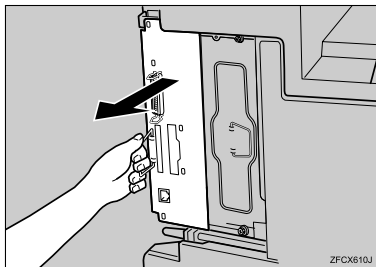

5 Put the printer board on a flat surface.

6 Insert the memory unit diagonally into the slot (①), and then push it down to the direction shown until it clicks into place (②).

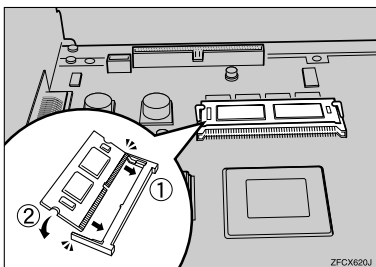

- 7** Align the printer board with the top and bottom rails in the printer, and then insert the printer board slowly until it clicks into place.

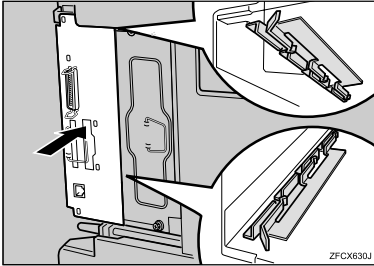

- 8** Lock the printer board with the two screws you removed in step **3**.

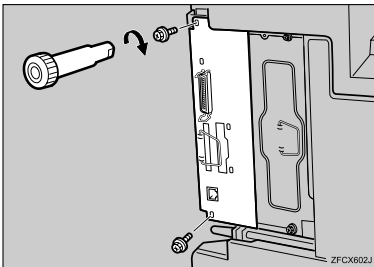

Note

- Print a configuration page to confirm that the unit is properly installed. See "Printing a Configuration Page" in the Printer Reference on the CD-ROM labeled "Operating Instructions".
- Be sure to return the screwdriver to the paper tray after using it.

Installing Paper Bank PS430

CAUTION:

- Before moving the machine, unplug the power cord from the outlet. If the cord is unplugged abruptly, it could become damaged. Damaged plugs or cords can cause an electrical or fire hazard.
- When lifting the machine, use the grips on both sides. The machine could break or cause an injury if dropped.
- When lifting the Paper Bank, hold the bottom of it, and then lift it slowly. Lifting it carelessly or dropping it may cause an injury.

Important

- When the bidirectional transmission is not in operation, you must set up the installed Paper Bank using the printer driver in order to use it. See p.37 "Installing the Printer Driver and Software" for setting up options. See p.48 "The conditions of the bidirectional transmissions" for information about bidirectional transmission.

- 1** Confirm that the printer is turned off, and the power cord is unplugged from the wall outlet.

- 2** Remove the tape that holds the Paper Bank, and then remove the packing material.

Important

- ❑ Do not remove the tape that holds the connector cable inside the connector cover on the back of the Paper Bank in this step. It is removed in step 10.

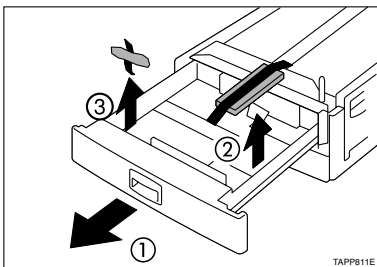
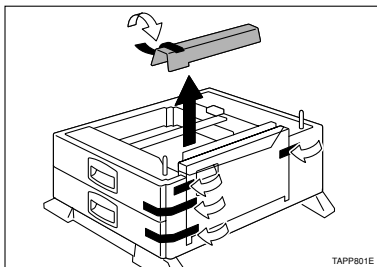

- 3** Check the contents of the box for the following items:

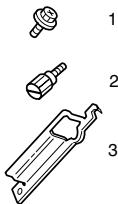

TAPD011E

1. Screw
2. Knob Screw (Finger type)
3. Lock Plate

- 4** Align the printer over the Paper Bank, and then lower it carefully onto the Paper Bank.

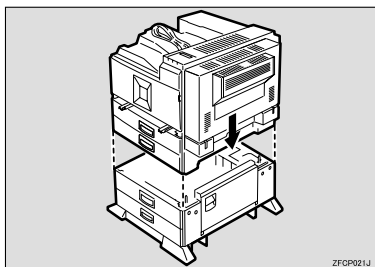

ZFCP021J

Important

- ❑ The printer should be held by at least two people.
- ❑ When lifting the printer, pull out the grips from the front of the printer. One person should hold the grips on the front and another person should hold the grips on the rear.

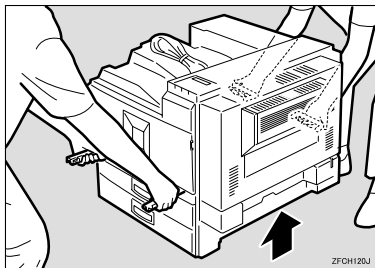

ZFCM120J

- 5** Push the grips into the printer. Take out the cover inside Tray 2 and attach it between the paper tray and the front cover.

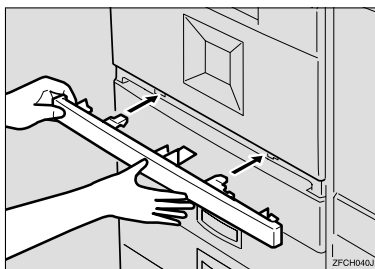

ZFCH040J

- 6** Pull the second paper tray (Tray 2) until it stops. After that, lift it slightly, and then pull it out.

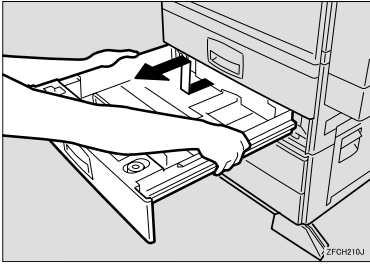

- 7** Pull out the first paper tray (Tray 1), and take the screwdriver (1) from the tray.

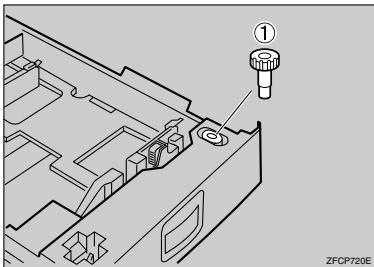

- 8** Lock the Paper Bank and the printer with the screw.

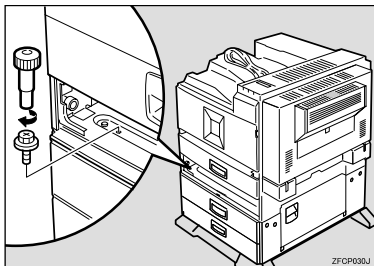

Note

- Be sure to return the screwdriver to the paper tray after using it.

- 9** Set the second paper tray (Tray 2) into the printer.

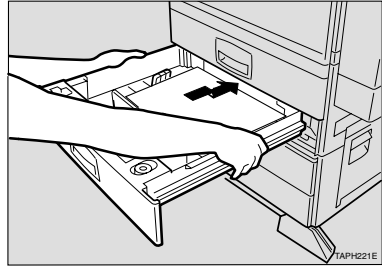

- 10** Open the lower vertical paper feed cover on the right side of the Paper Bank (1). Hang the lock plate hook in the hole inside (2), and then fasten the plate with the knob screw using your fingers.

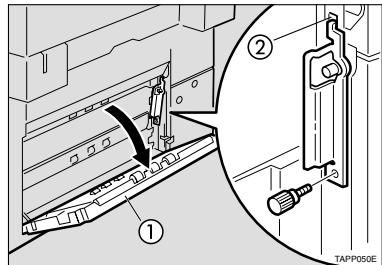

- 11** Close the lower vertical paper feed cover.

- 12** Open the connector cover (2), remove the tape that holds the connector cable and attach the connector cables (3) as shown in the illustration.

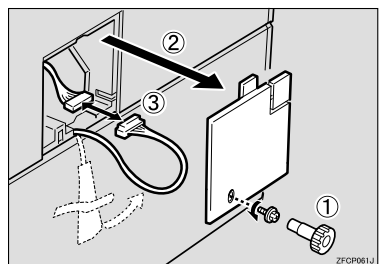

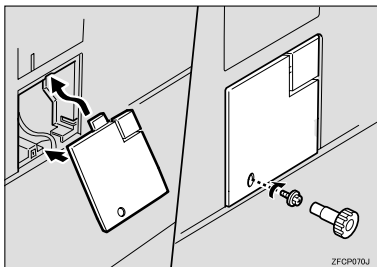
13 Close the connector cover.**Note**

- Print a configuration page to confirm that the Paper Bank is properly installed. See "Printing a Configuration Page" in the Printer Reference on the CD-ROM labeled "Operating Instructions".

Installing Printer Hard Disk Type4510

CAUTION:

- Do not touch the inside of the printer board compartment. It may cause a machine malfunction or a burn.

Important

- The Printer Hard Disk can be damaged by a small amount of static electricity. You should touch some metal to discharge static electricity.
- When the bidirectional transmission is not in operation, you must set up the installed Printer Hard Disk using the printer driver in order to use it. See p.37 "Installing the Printer Driver and Software" for setting up options. See p.48 "The conditions of the bidirectional transmissions" for information about bidirectional transmission.

- When the Printer Hard Disk is being accessed, the Data In indicator blinks. Do not turn off the printer power when the Data In indicator is blinking as it may destroy the hard disk.
- When a print job is being spooled, the printer sends data to the hard disk, and the Data In indicator blinks. Do not turn off the printer or computer while a print job is being spooled, as it may destroy the hard disk or the spooled job will remain in the hard disk and be printed repeatedly until erased.

1 Check the contents of the box for the following items:

- Printer Hard Disk
- Installation Guide
- Power Cord
- Connector

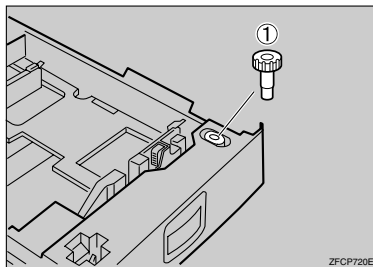
2 Turn off the printer.**3** Pull out the first paper tray (Tray 1) and take the screwdriver (1) from the tray. Each screw to be removed requires this screwdriver.

- 4** Remove the two screws locking the printer board.

The screws are needed to lock the printer board afterwards.

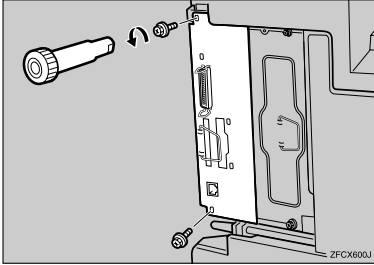

- 5** Remove the two screws locking the Printer Hard Disk cover next to the printer board.

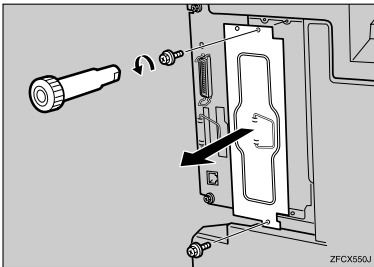

The screws are needed to lock the cover afterwards.

- 6** Align the Printer Hard Disk with the top and bottom rails, and then insert the Printer Hard Disk slowly until it stops.

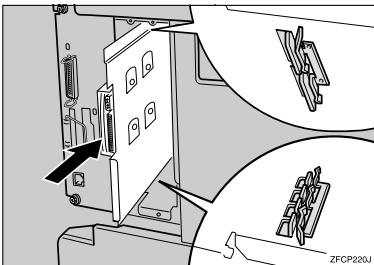

- 7** Hold the handle, and carefully pull out the printer board half-way.

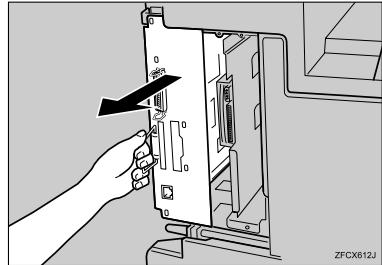

- 8** Connect the bigger plug of the power cord to the printer board.

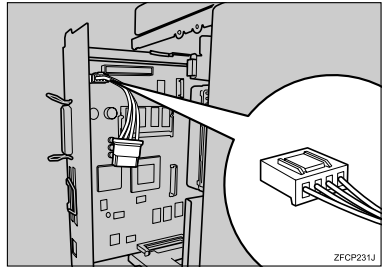

- 9** Connect the connector to the printer board.

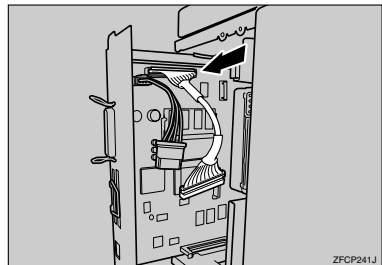

Note

- Connect either side of the connector.

2

- 10** Connect the power cord to the Printer Hard Disk.

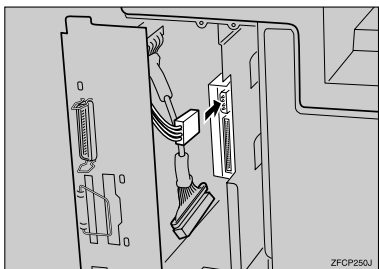

- 11** Connect the connector to the Printer Hard Disk.

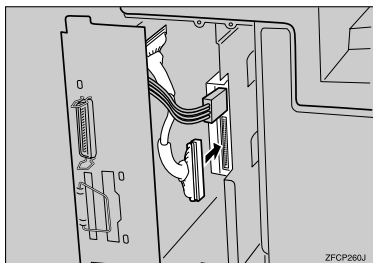

- 12** Lock the Printer Hard Disk cover with the two screws you removed in step 5.

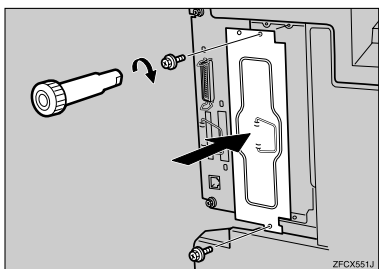

- 13** Align the printer board with the top and bottom rails in the printer, and then insert the printer board slowly until it stops.

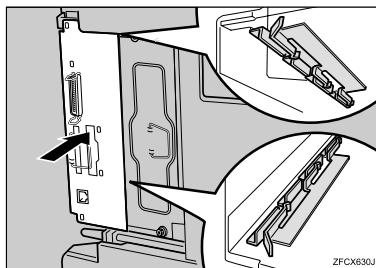

- 14** Lock the printer board with the two screws you removed in step 4.

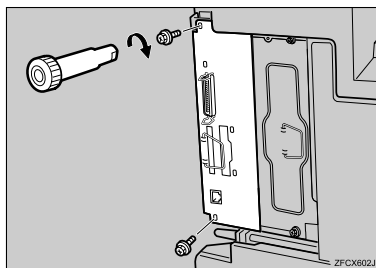

Note

- Be sure to return the screwdriver to the paper tray after using it.

The Printer Hard Disk will be formatted automatically when the power is turned on.

Note

- Print a configuration page to confirm that the Printer Hard Disk is properly installed. See "Printing a Configuration Page" in the Printer Reference on the CD-ROM labeled "Operating Instructions".

Formatting Printer Hard Disk Type4510

If you are formatting the Printer Hard Disk from the menu, follow the procedures below while using the control panel.

1 Press **[Menu]**.

"Menu" appears on the panel display.

```
Menu:
Maintenance
```

2 Press **[▲]** or **[▼]** to display the "Maintenance" menu.

3 Press **[Enter #]**.

The following message appears on the panel display.

```
Menu:
Image Density
```

4 Press **[▲]** or **[▼]** to display "HDD Format".

```
Menu:
HDD Format
```

Note

- If "HDD Format" is not displayed, the Printer Hard Disk is not installed properly. In such a case, reinstall from step 2.

5 Press **[Enter #]**.

The following message appears on the panel display.

```
HDD Format:
Press# to Start
```

6 Press **[Enter #]**.

Important

- Do not turn off the printer while formatting the Printer Hard Disk. Turning off the printer while formatting the Printer Hard Disk can damage the Printer Hard Disk.

If you successfully format the Printer Hard Disk, the following message appears on the panel display.

```
Completed
Restart Printer
```

Note

- If you fail, see "Troubleshooting" in the Printer Reference, on the CD-ROM labeled "Operating Instructions".

7 Turn off the power switch, and then back on.

Installing 1394 Interface Unit Type 4510

⚠ CAUTION:

- Do not touch the inside of the printer board compartment. It may cause a machine malfunction or a burn.

🔧 Important

- In Windows 2000, the 1394 Interface Unit can only be used with Service Pack 1 or later. If the Service Pack is not installed, the connectable number of devices in a 1394 bus is only one, and the client cannot access the 1394 Interface Unit without using an account that has the administrators permission.
- The 1394 Interface Unit can be damaged by a small amount of static electricity. You should touch some metal to discharge static electricity.
- Use the 1394 interface cable that comes with this printer.
- Do not plug or unplug the 1394 interface cable while installing the printer driver.
- Do not turn the device on or off, while installing the printer driver.
- When the 1394 Interface Unit is installed, uninstall the printer driver after the 1394 interface cable is unplugged.
- Before pulling out printer board, make sure that the printer's power switch is off, and 1394 interface cables are unplugged. If there is electricity provided from the equipment connected with the 1393 interface cables, the printer board and the 1394 Interface Unit might be damaged.

Installing the 1394 Interface Unit

- Check the contents of the box for the following items:

- 1394 Interface Unit
- 1394 interface cable (6-pin x 4-pin)
- 1394 interface cable (6-pin x 6-pin)
- Installation Guide

🔧 Note

- Other provided parts are not to be used.

- Turn off the printer.

- Pull out the first paper tray (Tray 1) and take the screwdriver (1) from the tray. Each screw to be removed requires this screwdriver.

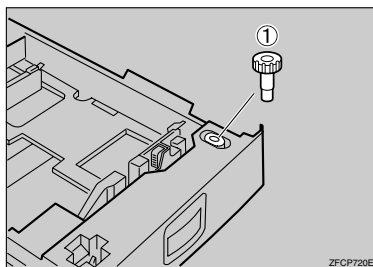

- Remove the two screws locking the printer board.

The screws are needed to lock the printer board afterwards.

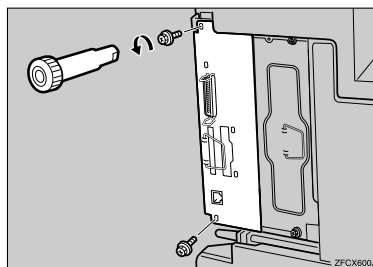

- 5** Hold the handle, and carefully pull out the printer board.

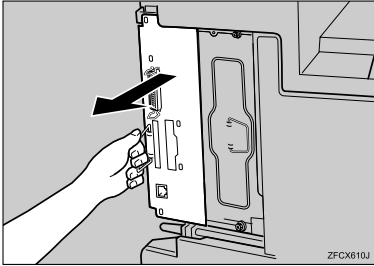

- 6** Put the printer board on a flat surface.

- 7** Remove the two screws locking the 1394 Interface Unit cover.

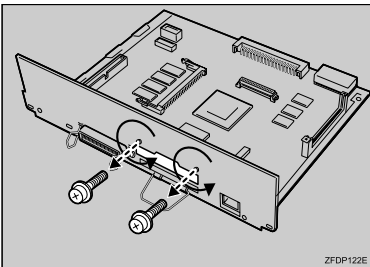

The screws are needed to lock the 1394 Interface Unit afterwards.

- 8** Attach the 1394 Interface Unit to the slot. Confirm that the unit is firmly connected to the printer board.

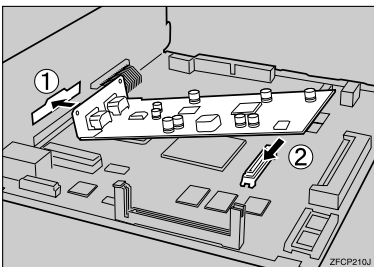

- 9** Lock the 1394 Interface Unit cover with the two screws you removed in step **7**.

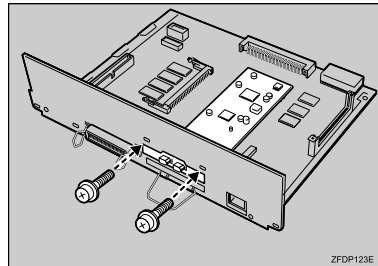

- 10** Align the printer board with the top and bottom rails in the printer, and then insert the printer board slowly until it stops.

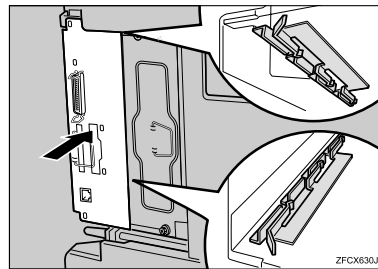

- 11** Lock the printer board with the two screws you removed in step **4**.

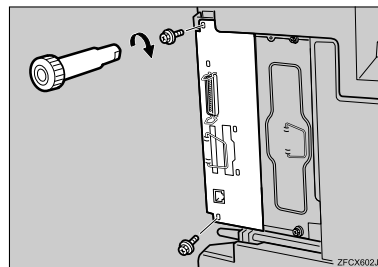

Note

- Be sure to return the screwdriver to the paper tray after using it.
- Print a configuration page to confirm that the unit is properly installed. See "Printing a Configuration Page" in the Printer Reference, on the CD-ROM labeled "Operating Instructions".

Connecting the 1394 interface cable to the printer

1 Attach the 1394 interface cable to the jack on the board.

Both jacks are available.

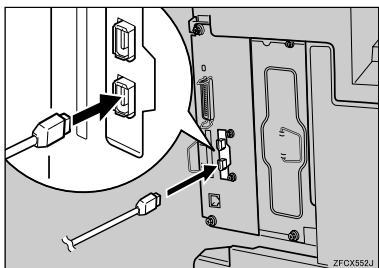

2 Connect the other end of the 1394 interface cable to the computer or the other IEEE 1394 node.

Note

- The 1394 Interface Unit could not receive data from more than one PC at the same time. In this case, an error message appears. The printer can accept data sent from other computers, after the first print job has finished.
- The bidirectional transmissions are not supported by the 1394 Interface Unit.
- When the 1394 Interface Unit is installed successfully, the printer icon automatically changes from "Use Printer Offline" to "Ready", according to the 1394 interface cable plug.

- To use the 1394 Interface Unit, configure the unit from the control panel of the printer.

Printing with SCSI Print

You can print by directly connecting the computer to the printer via the 1394 Interface cable and using the SCSI print client function provided with Windows 2000.

Limitation

- This function is available under Windows 2000 only. It is not available under Windows 95/98/Me or Windows NT 4.0.

Installing the Printer Driver

- "SCSI print" must be set active from the control panel. For more information, see p.34 "IEEE 1394 Configuration".
- If the connected printer's driver is not installed, follow the procedure below.
 - ① Connect this machine to your computer with the 1394 interface cable.
 - ② Press **[Cancel]** when "Detect New Hardware Wizard" appears. If the same wizard reappears, press **[Cancel]** again.
 - ③ Insert the printer driver CD-ROM into the computer.
- For the port selection, select the IEEE 1394 port.
- For more information about the installation of the printer driver, see p.37 "Installing the Printer Driver and Software".

- If the printer driver for the connected printer has already been installed, the icon is automatically added to the Printers folder. In this case, driver installation is not necessary. However, since the 1394 Interface Unit does not support bidirectional transmissions, if options are installed, set up options from the Printer Driver Properties. See p.37 "Installing the Printer Driver and Software".

If the 1394 Interface Unit has been installed properly, the printer icon automatically changes from "Use Printer Offline" to "Ready" whenever the 1394 interface cable is connected.

Important

- If [Add Printer Wizard] starts on the computer running Windows 95/98/Me, click [Cancel].
- Do not connect new IEEE 1394 or USB devices to the printer or turn on the printer while installing the printer driver.
- To uninstall the printer driver, first disconnect the 1394 interface cable.

Note

- The 1394 Interface Unit cannot accept print data from more than one computer at the same time. If a computer sends print data while it is receiving print data from another computer, an error message appears.
- The 1394 Interface Unit does not support bidirectional transmissions.

Printing with IP over 1394

With the IPP driver of Windows Me and by setting the IEEE 1394 Interface IP Address for the IEEE 1394 with the printer, you can make prints from a computer running Windows Me.

Preparation

"IP over 1394" must be set on the control panel and an IEEE 1394 Interface IP address must be specified.

For more information about how to make printer settings, see p.34 "IEEE 1394 Configuration".

Limitation

- With Windows Me, the provided 1394 driver can be used. Windows 95/98, Windows 2000, Windows NT 4.0, and Macintosh do not support "IP over 1394".
- When using the 1394 Interface Unit in a network, the Ethernet interface cannot be used in the same network.
- Set the Subnet Masks for the 1394 Interface Unit and the Ethernet interface so they do not overlap.

Note

- The supported protocols are IPP and FTP.
 - To use IPP, see p.26 "Installing the Printer Driver".
 - To use FTP, see the Network Printing Guide.
- The maximum number of simultaneous print requests when connecting with IP over 1394 includes the print requests from the Ethernet interface. For more information, see the Network Printing Guide.

Installing the Printer Driver

You need the Microsoft Windows Me CD-ROM for the installation.

To find out whether the Windows Me CD-ROM supplied by another supplier includes the IPP driver, contact the each supplier.

1 Insert the Windows Me CD-ROM into the CD-ROM drive.

2 Auto Run will start the Windows Millennium CD-ROM.

3 Click **[Browse This CD]**.

A window showing the contents of the CD-ROM appears.

4 Double-click the **[add-ons]** folder.

5 Double-click the **[lpp]** folder.

For more information about installing the IPP Client, see the **[lpp]** file in the **[lpp]** folder.

6 Restart the computer and remove the Windows Me CD-ROM from the CD-ROM drive.

7 Click **[Start]**, point to **[Settings]**, and then click **[Printers]**.

8 Double-click **[Add Printer]**.

The "Add Printer Wizard" starts.

9 Click **[Next>]**.

10 Select the **[Network Printer]** check box, and then click **[Next>]**.

11 In **[Network path or queue name]**, type **[http://<IP address of printer>/printer]** for the printer IP address and the port number, and then click **[Next>]**.

12 Click **[Next>]**.

13 Click **[Have Disk...]**.

The "Install From Disk" dialog box appears.

14 Insert the CD-ROM labeled "Printer Drivers and Utilities" that comes with the printer.

15 Click **[Browse...]**.

16 Select the CD-ROM drive from the drop-down list in the **[Drives]** box.

17 Select the folder containing the printer driver you want to install, and then click **[OK]**.

18 Click **[OK]**.

19 Select the computer you use, and then click **[Next>]**.

20 Change **[Printer name]** as necessary, and then click **[Next>]**.

21 Check the configuration page, select **[No]**, and then click **[Finish]**.

Installation starts.

22 Restart Windows.

The printer driver installation is complete.

Configuration and Usage from a Web Browser

Preparation

If you want to use this printer from a Web browser, its IP address must be specified and the TCP/IP protocol (IP over 1394) set on the control panel. For more information, see p.34 "IEEE 1394 Configuration".

When you browse the printer on the network by the Web browser, you need not to use the proxy server.

When setting an IEEE 1394 Interface IP address for the printer, use an address that can be used without the proxy server.

Configuration

- 1** Start the Web browser.
- 2** Enter [<http://<IP address of printer whose state you want to display>/>] in the address bar.
The selected printer status will appear in the Web browser.
- 3** Click [OK].
A dialog box for entering a User Name and Password will appear.
- 4** Enter the User Name and Password, and then click [OK].
The printer is factory-configured so you can leave the User Name blank and enter "pass" as the password.

- 5** Click [IEEE 1394].

Make all the necessary settings.

Note

- For more information about the installation procedure, see Help.
- To access Help, the computer must be connected to the Internet. With a dial-up connection, there may be a connection charge to pay.
- Help is stored as an HTML file on the CD-ROM that comes with this printer. To see it, open "\\HELP\WSMHELP**\index.html" on the CD-ROM. (** stands for the language.)

Checking the Settings

- 1** Start the Web browser.
- 2** Enter [<http://<IP address of printer whose state you want to display>/>] in the address bar.
The selected printer status will appear in the Web browser.
- 3** Click [Setting Reference].
- 4** Click [IEEE 1394].
You can now check the settings you have made.

Troubleshooting

IEEE 1394 Printer Removal Utility

If you cannot print when the printer is connected via the 1394 Interface Unit or error messages appear, follow the procedure:

- 1** Make sure the 1394 Interface Unit is installed properly.
- 2** Make sure the IEEE 1394 cable is connected properly.
- 3** Restart the computer.
If the problem still exists, go to step **4**.
- 4** Disconnect all the IEEE 1394 cables from the computer.
- 5** If you uninstall the printer driver when the printer is connected to a computer with "SCSI print", the printer driver may not be uninstalled properly. To uninstall the driver properly, use the IEEE 1394 Printer Removal Utility on the CD-ROM that comes with the printer.

Stored in: CD-ROM labeled "Printer Drivers and Utilities" \DRIVERS\UTILITY\1394\

 **Note**

- For more information about the IEEE 1394 Printer Removal Utility, see the README file in the same folder as the program.

- 6** Restart the computer.

Invalidate Device for Windows 2000

With Windows 2000, if "Detect New Hardware Wizard" appears every time you restart the computer or unplug the cable, invalidate the device using the following procedure.

- 1** In "Start to Search New Hardware Wizard", click [Next].
- 2** Confirm that "Automatic search for a better driver [Recommended]" is selected in "Installation of the Hardware Device Driver", and then click [Next].
Uncheck all the check boxes in "Searching Location Options" in "Specification of Driver File", and then click [Next].
- 3** Clear all the check boxes in "Searching Location Options" in "Specification of Driver File", and then click [Next].
- 4** Confirm that "Invalidate Device" in "Search for Driver File" is selected, and then click [Finish].

Invalidate Device for Windows Me

With Windows Me, if "Add New Hardware Wizard" starts every time you restart the computer or unplug the cable, invalidate the device using the following procedure.

- 1** If "Windows has found the following new hardware:" appears, confirm that "Automatic search for a better driver [Recommended]" is selected, and then click [Next].
- 2** When "Windows was unable to locate the software for this device." appears, click [Finish].

 **1394 Interface Unit
specification****❖ Operating System:**

Windows 2000 Service Pack 1 or later (when connecting with SCSI print)
Windows Me (when connecting with IP over 1394)

❖ Interface:

IEEE Std 1394-1995 compliant,
IEEE Std 1394a-2000 compliant

❖ Interface Connector:

IEEE 1394 (6-pin × 2)

❖ Data Transmission:

400 Mbps (maximum)

❖ Required cable:

1394 interface cable (6-pin × 4-pin,
6-pin × 6-pin)

 Important

- You cannot plug devices together to create loops.
- Do not use a cable more than 4.5 meters (14.8 feet) long.

❖ Connectable number of devices in a bus:

Maximum 63

❖ Allowed cable hops in a bus:

Maximum 16

❖ Length of cable:

4.5 meters (maximum per hop)

❖ Power supply:

Non power supply
Cable Power repeated (IEEE1394a-2000 compliant)

❖ Power repeat:

IEEE Std 1394a-2000 compliant



2

3. Configuring the Printer for the Network for the Network

Configuring the Printer for the Network with the Control Panel

After installing the optional Network Interface Board, configure it for the network using the printer's control panel.

Configure the printer for the network using the printer's control panel.

The following table shows the control panel settings and their default settings. These are included in the "Host Interface" menu.

Reference

For information about configuring the computer for the network, see the Network Printing Guide on the CD-ROM labeled "Operating Instructions".

For information about "Host Interface" menu, see "Host Interface Menu" in the Printer Reference on the CD-ROM labeled "Operating Instructions".

Setting Name	Value	
IP Address	011.022.033.044	
Subnet Mask	000.000.000.000	
Gateway Address	000.000.000.000	
Network Boot	None	
Frame Type (NW) (Frame type NetWare)	Auto	
Active Protocol	TCP/IP	<input type="radio"/> *1
	NetWare	<input type="radio"/> *1
	NetBEUI	<input type="radio"/> *1
	AppleTalk	<input type="radio"/> *1
Ethernet	Auto	

*1 means that this protocol is active.

1 Press [Menu].

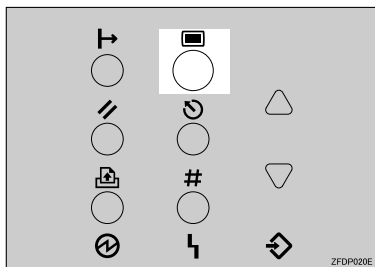

"Menu" appears on the panel display.

2 Press [▲] or [▼] to display "Host Interface" menu.

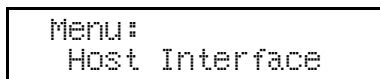

3 Press [Enter #].

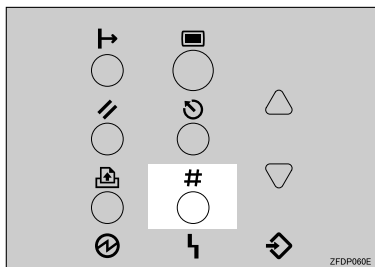

The following message appears on the panel display.

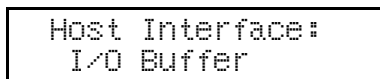

- 4** Press **[▲]** or **[▼]** to display “Network Setup”.

```
Host Interface:
Network Setup
```

- 5** Press **[Enter #]**.

The following message appears on the panel display.

```
Network Setup:
IP Address
```

- 6** Select the protocol you want to use.

 **Note**

- Do not select protocols that are not used on your network.

- 1** Press **[▲]** or **[▼]** to display “Active Protocol”.

```
Network Setup:
Active Protocol
```

- 2** Press **[Enter #]**.

The current setting appears on the panel display.

```
Active Protocol:
TCP/IP
```

- 3** Set other protocols you need to set in the same way.

 **Note**

- Leave unused protocols "Not Active".

- 7** If you use TCP/IP, you should assign the IP address to the printer.

 **Note**

- To get the IP address for the printer, contact your network administrator.

- 1** Press **[▲]** or **[▼]** until the following message appears.

```
Network Setup:
IP Address
```

- 2** Press **[Enter #]**.

The current IP address appears on the panel display.

```
IP Address:
011.022.033.044
```

- 3** Press **[▲]** or **[▼]** to enter the left most entry field of the IP address.

```
IP Address:
192.022.033.044
```

- 4** Press **[Enter #]**.

The pointer (█) moves to the next entry field automatically.

```
IP Address:
192.02█.033.044
```

 **Note**

- You can return the pointer (█) to the previous (left) entry field by pressing **[Escape]**.
- If you press **[Escape]** when the pointer (█) is on the leftmost position, the selected IP address is reset.

- 5** Repeat steps **3** and **4** to enter the IP address.

```
IP Address:
192.168.000.011
```

Check if the pointer (█) is at the rightmost position, and press **[Enter #]** to register the IP address you selected.

```
Network Setup:
IP Address
```

8 If you use TCP/IP, you should assign "Subnet Mask" and "Gateway Address" following the same procedure for entering the IP address.

9 If you use TCP/IP, you can make settings for "Network Boot".

You can select how to assign the printer's address using the computer. Select one of the items below if necessary.

- None (Default)
- DHCP

1 Press **[▲]** or **[▼]** to display "Network Boot".

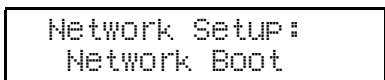

2 Press **[Enter #]**.

The current setting appears on the panel display.

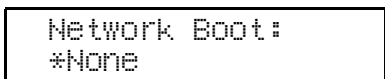

3 Press **[▲]** or **[▼]** to display the method you want to use.

4 Press **[Enter #]**.

10 If you use NetWare, select the frame type for NetWare.

Select one of items below if necessary.

- Auto (Default)
- Ethernet 802.3
- Ethernet 802.2
- Ethernet II
- Ethernet SNAP

Note

Usually, use the default setting ("Auto "). When you first select "Auto ", the frame type detected by the printer is adopted. If your network can use more than two frame types, the printer may fail to select the correct frame type if "Auto " is selected. In this case, select the appropriate frame type.

1 Press **[▲]** or **[▼]** to display "Frame Type (NW)".

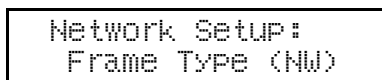

2 Press **[Enter #]**.

The current setting appears on the panel display.

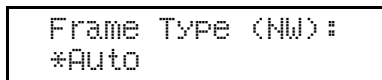

3 Press **[▲]** or **[▼]** to display the frame type you want to use.

4 Press **[Enter #]**.

11 Press **[On Line]**.

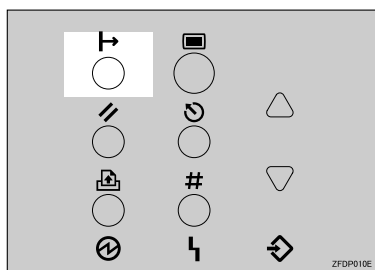

"Ready" appears on the panel display.



12 Print a configuration page to confirm the settings made. See "Printing a Configuration Page" in the Printer Reference.

IEEE 1394 Configuration

Configure the printer for using in the IEEE 1394 environment. The following table shows the control panel settings and their default settings. These are included in the "Host Interface" menu.

Setting Name	Value
IP Address1394	011.022.033.044
Subnet Mask1394	000.000.000.000
IP over 1394	IP over 1394
SCSI print	Active

1 Press **[Menu]**.

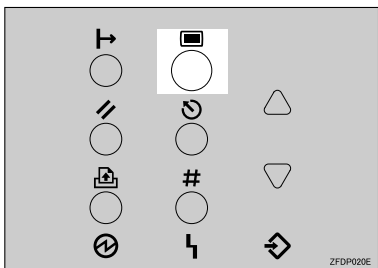

"Menu" appears on the panel display.

2 Press **[▲]** or **[▼]** to display "Host Interface" menu.

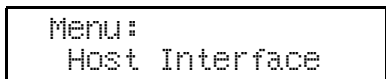

3 Press **[Enter #]**.

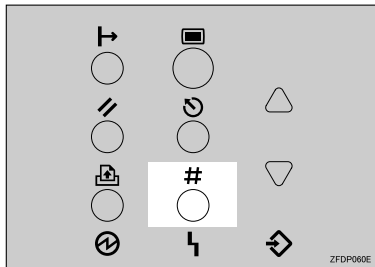

The following message appears on the panel display.

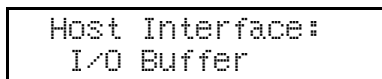

4 Press **[▲]** or **[▼]** to display "IEEE 1394 Setup".

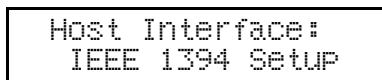

5 Press **[Enter #]**.

The following message appears on the panel display.

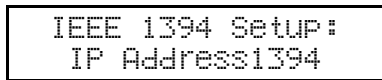

6 Press **[▲]** or **[▼]** to display "IP over 1394".

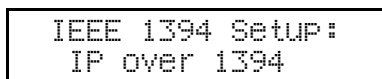

1 Press **[Enter #]**.

2 Press **[▲]** or **[▼]** to select either "Active" or "Not Active".

3 Press **[Enter #]**.

The display returns to the previous menu in about two seconds.

7 Set "SCSI print" in the same way.

8 Assign the IP address to the printer.

 **Note**

- To get the IP address for the printer, contact your network administrator.

1 Press **[▲]** or **[▼]** until the following message appears.

```
IEEE 1394 Setup:
IP Address1394
```

2 Press **[Enter #]**.

The current IP address appears on the panel display.

```
IP Address1394:
011.022.033.044
```

3 Press **[▲]** or **[▼]** to enter the leftmost entry field of the IP address.

```
IP Address1394:
192.022.033.044
```

4 Press **[Enter #]**.

The pointer (█) moves to the next entry field automatically.

```
IP Address1394:
192.02█.033.044
```

 **Note**

- You can return the pointer (█) to the previous (left) entry field by pressing **[Escape]**.
- If you press **[Escape]** when the pointer (█) is on the leftmost position, the selected IP address is reset.

5 Repeat steps **3** and **4** to enter the IP address.

```
IP Address1394:
192.168.000.011
```

Check if the pointer (█) is at the rightmost position, and press **[Enter #]** to register the IP address you selected.

```
IEEE 1394 Setup:
IP Address1394
```

9 Set "Subnet Mask1394" in the same way.

10 Press **[On Line]**.

"Ready" appears on the panel display.

```
Ready
```

11 Print a configuration page to confirm the settings made. See "Printing a Configuration Page" in the Printer Reference.

 **Address**

◆ **Subnet Mask**

A number used to mathematically "mask" or hide an IP address on the network by eliminating those parts of the address that are alike for all the machines on the network.

◆ **Gateway Address**

A gateway is a connection or interchange point that connects two networks. A gateway address is for the router or host computer used as a gateway.

 **Note**

- To get the addresses, contact your network administrator.

3

4. Installing the Printer Driver and Software

This manual assumes that you are familiar with general Windows procedures and practices. If you are not, see the documentation that comes with Windows for details.

Installation Method

The following table shows how to install the printer drivers and software.

	Auto Run ^{*1}		
	Quick Install		Custom installation ^{*2}
	Network connection with TCP/IP	Parallel connection	
PCL 6 printer driver	<input type="radio"/>	<input type="radio"/>	<input type="radio"/>
PCL 5e printer driver			<input type="radio"/>
RPCS printer driver	<input type="radio"/>	<input type="radio"/>	<input type="radio"/>
PostScript printer driver			<input type="radio"/>
Agfa Monotype Font Manager 2000			<input type="radio"/>
SmartNetMonitor for Admin			<input type="radio"/>
SmartNetMonitor for Client	<input type="radio"/>		<input type="radio"/>

^{*1} Available operating systems are as follows: Windows 95/98/Me, Windows 2000, Windows NT 4.0

^{*2} Using custom installation, you can install various software separately.

Important

- Before starting this installation, close all documents and applications. In a network environment, confirm that users who are logged on are disconnected. Be sure to do this when it will create the least interference with other users.
- After installing a printer driver, you must restart the computer.

Note

- If the "plug and play" function is started, click **[Cancel]** in the **[New Hardware Found]**, **[Device Driver Wizard]** or **[Found New Hardware Wizard]** dialog box, and then insert the CD-ROM. The **[New Hardware Found]**, **[Device Driver Wizard]** or **[Found New Hardware Wizard]** dialog box appears depending on the system version of the Windows 95/98/Me, Windows 2000.

Quick Install

Auto Run will start the installer automatically when you load the CD-ROM in the CD-ROM drive. By selecting Quick Install, you can install the necessary software easily.

TCP/IP requires the following:

- This machine must be connected to the network through the network interface cable.
- This machine must be turned on.
- The TCP/IP protocol must be configured.
- An IP address must be allocated to this machine and to the computer.

4

⚠ Limitation

- ❑ If your system is Windows 2000 or Windows NT 4.0, installing a printer driver by Auto Run requires Administrators permission. When you install a printer driver by Auto Run, log on using an account that has Administrators permission.

📝 Note

- ❑ Auto Run might not automatically work with certain OS settings. In this case, launch "Setup.exe" located on the CD-ROM root directory.

If you want to cancel Auto Run, hold down the **[SHIFT]** key (when your system is Windows 2000, hold down the left **[SHIFT]** key) while inserting the CD-ROM. Keep the **[SHIFT]** key held down until the computer has finished accessing the CD-ROM.

1 Close all applications that are running.

2 Insert the CD-ROM into the CD-ROM drive.

Auto Run will start the installer.

3 Select a language to change the interface language, and then click **[OK]**.

The following languages are available: Cestina (Czech), Dansk (Danish), Deutsch (German), English (English), Espanol (Spanish), Francais (French), Italiano (Italian), Magyar (Hungarian), Nederlands (Dutch), Norsk (Norwegian), Polski (Polish), Portugues (Portuguese), Suomi (Finnish), Svenska (Swedish)

Default interface language is English.

4 Select **[Quick Install]**.

5 The software license agreement appears in the **[License Agreement]** dialog box.

After reading through all of the contents, click **[I accept the agreement]** to agree with the license agreement, and then click **[Next]**.

6 Click to select a model name you want to use when the "Select Printer" dialog box appears.

 **Note**

- For a network connection with TCP/IP, select the printer whose IP address is displayed in **[Connect To]**.
- For parallel connection, select the printer whose printer port is displayed in **[Connect To]**.

7 Click **[Install]**.

8 Follow the instructions on the screen.

 **Note**

- During installation in Windows 2000, the **[Digital Signature Not Found]** dialog box may appear. In this case, click **[Yes]** to continue the installation.

A message prompting you to restart your computer may appear. To complete the installation, restart your computer.

Installing the PCL 6/5e Printer Driver

Installing the PCL 6/5e Printer Driver

Two kinds of PCL printer drivers, PCL 6 and PCL 5e, are provided with this printer. We recommend PCL 6 as your first choice.

Limitation

- If your system is Windows 2000 or Windows NT 4.0, installing a printer driver by Auto Run requires Administrators permission. When you install a printer driver by Auto Run, log on using an account that has Administrators permission.

Important

- When updating the printer driver by installing the latest version, you should uninstall that of former version if any. See *"Uninstalling the Printer Driver and Software"* in the Printer Reference.

1 Close all applications that are running.

2 Insert the CD-ROM into the CD-ROM drive.

Auto Run will start the installer.

3 Select a language to change the interface language, and then click **[OK]**.

The following languages are available: Cestina (Czech), Dansk (Danish), Deutsch (German), English (English), Espanol (Spanish), Francais (French), Italiano (Italian), Magyar (Hungarian), Nederlands (Dutch), Norsk (Norwegian), Polski (Polish), Portugues (Portuguese), Suomi (Finnish), Svenska (Swedish)

Default interface language is English.

4 Select **[PCL/RPCS Printer Drivers]**.

5 The software license agreement appears in the **[License Agreement]** dialog box.

After reading through all of the contents, click **[I accept the agreement]** to agree with the license agreement, and then click **[Next]**.

6 Select the printer driver you want to install when the "Select Program" dialog box appears.

7 Follow the instructions on the screen.

Note

- During installation in Windows 2000, the **[Digital Signature Not Found]** dialog box may appear. In this case, click **[Yes]** to continue the installation.

Setting up options

Important

- If the printer is equipped with certain options, you should set up the options with the printer driver.

Limitation

- In Windows 2000, changing the printer settings requires Manage Printers permission. Members of the Administrators and Power Users groups have Manage Printers permission by default. When you set up options, log on using an account that has Manage Printers permission.
- In Windows NT4.0, changing the setting of the printer requires Full Control permission. Members of the Administrators, Server Operators, Print Operators, and Power Users groups have Full Control permission by default. When you set up options, log on using an account that has Full Control permission.

Note

- When setting up options, you should access the Printer Properties dialog box from Windows. You cannot set up options by accessing the Printer Properties dialog box from an application.

1 Click **[Start]** on the taskbar, point to **[Settings]**, and then click **[Printers]**.

The **[Printers]** window appears.

2 Click to select the icon of the printer you want to use.

3 On the **[File]** menu, click **[Properties]**.

The Printer Properties appear.

4 Click the **[Accessories]** tab.

5 Select options you have installed from the **[Options]** group.

6 Click **[OK]**.

Installing the RPCS Printer Driver

Installing the RPCS Printer Driver

Limitation

- If your system is Windows 2000 or Windows NT 4.0, installing a printer driver by Auto Run requires Administrators permission. When you install a printer driver by Auto Run, log on using an account that has Administrators permission.

Important

- When updating the printer driver by installing the latest version, you should uninstall that of former version if any. See *"Uninstalling the Printer Driver and Software"* in the Printer Reference.

1 Close all applications that are running.

2 Insert the CD-ROM into the CD-ROM drive.

Auto Run will start the installer.

3 Select a language to change the interface language, and then click **[OK]**.

The following languages are available: Cestina (Czech), Dansk (Danish), Deutsch (German), English (English), Espanol (Spanish), Francais (French), Italiano (Italian), Magyar (Hungarian), Nederlands (Dutch), Norsk (Norwegian), Polski (Polish), Portugues (Portuguese), Suomi (Finnish), Svenska (Swedish)

Default interface language is English.

4 Select **[PCL/RPCS Printer Drivers]**.

5 The software license agreement appears in the **[License Agreement]** dialog box.

After reading through all of the contents, click **[I accept the agreement]** to agree with the license agreement, and then click **[Next]**.

6 Select the RPCS printer driver when the "Select Program" dialog box appears.

7 Follow the instructions on the screen.

Note

- During installation in Windows 2000, the **[Digital Signature Not Found]** dialog box may appear. In this case, click **[Yes]** to continue the installation.

Setting up options

Important

- If the printer is equipped with certain options, you should set up the options with the printer driver.

Limitation

- In Windows 2000, changing the printer settings requires Manage Printers permission. Members of the Administrators and Power Users groups have Manage Printers permission by default. When you set up options, log on using an account that has Manage Printers permission.
- In Windows NT4.0, changing the setting of the printer requires Full Control permission. Members of the Administrators, Server Operators, Print Operators, and Power Users groups have Full Control permission by default. When you set up options, log on using an account that has Full Control permission.

Note

- When setting up options, you should access the Printer Properties dialog box from Windows. You cannot set up options by accessing the Printer Properties dialog box from an application.

1 Click **[Start]** on the taskbar, point to **[Settings]**, and then click **[Printers]**.

The **[Printers]** window appears.

2 Click to select the icon of the printer you want to use.

3 On the **[File]** menu, click **[Properties]**.

The Printer Properties appear.

4 Click the **[Accessories]** tab.

5 Select options you have installed from the **[Options]** group.

6 Click **[OK]**.

Installing the PostScript Printer Driver

This section describes basic instructions for installing the PostScript printer driver. The actual procedure may differ depending on the operating system. Follow the appropriate procedures below.

Important

- When updating the printer driver by installing the latest version, you should uninstall that of former version if any. See *"Uninstalling the Printer Driver and Software"* in the Printer Reference.

Windows 95/98/Me - Installing the PostScript Printer Driver

4

Installing the printer driver

1 Close all applications that are running.

2 Insert the CD-ROM into the CD-ROM drive.

Auto Run will start the installer.

3 Select a language to change the interface language, and then click [OK].

The following languages are available: Cestina (Czech), Dansk (Danish), Deutsch (German), English (English), Espanol (Spanish), Francais (French), Italiano (Italian), Magyar (Hungarian), Nederlands (Dutch), Norsk (Norwegian), Polski (Polish), Portugues (Portuguese), Suomi (Finnish), Svenska (Swedish)

Default interface language is English.

Note

- The printer driver with the selected language will be installed.
- The printer driver will be installed in English if you select the following languages: Cestina, Magyar, Polski, Portugues and Suomi.

4 Select [PostScript 3 Printer Driver].

[Add Printer Wizard] starts.

5 Click [Next].

6 Check [Local Printer] and then click [Next].

A dialog box for selecting the printer appears.

7 Select the printer you want to use, and then click [Next].

8 Follow the instructions on the screen.

Setting up options

Important

- If the printer is equipped with certain options, you should set up the options with the printer driver.

1 Click **[Start]** on the taskbar, point to **[Settings]**, and then click **[Printers]**.

The **[Printers]** window appears.

2 Click to select the icon of the printer you want to use.

3 On the **[File]** menu, click **[Properties]**.

The Printer Properties appear.

4 Click the **[Accessories]** tab.

5 Select options you have installed from the **[Options]** group.

6 Click **[OK]**.

Windows 2000 - Installing the PostScript Printer Driver

Installing the printer driver

Limitation

- Installing a printer driver requires Administrators permission. When you install a printer driver, log on using an account that has Administrators permission.

1 Close all applications that are running.

2 Insert the CD-ROM into the CD-ROM drive.

Auto Run will start the installer.

3 Select a language to change the interface language, and then click **[OK]**.

The following languages are available: Cestina (Czech), Dansk (Danish), Deutsch (German), English (English), Espanol (Spanish), Francais (French), Italiano (Italian), Magyar (Hungarian), Nederlands (Dutch), Norsk (Norwegian), Polski (Polish), Portugues (Portuguese), Suomi (Finnish), Svenska (Swedish)

Default interface language is English.

Note

- The printer driver with the selected language will be installed.
- The printer driver will be installed in English if you select the following languages: Cestina, Magyar, Polski, Portugues and Suomi.

4 Select **[PostScript 3 Printer Driver]**.

[Add Printer Wizard] starts.

5 Click **[Next]**.

6 Check **[Local Printer]** and then click **[Next]**.

A dialog box for selecting the printer port appears.

7 Select the check box of the port you want to use, and then click **[Next]**.

A dialog box for selecting the printer appears.

8 Select the printer you want to use, and then click **[Next]**.

9 Follow the instructions on the screen.

 **Note**

- During installation, the **[Digital Signature Not Found]** dialog box may appear. In this case, click **[Yes]** to continue the installation.

Setting up options

Important

- If the printer is equipped with certain options, you should set up the options with the printer driver.

Limitation

- Changing the printer settings requires Manage Printers permission. Members of the Administrators and Power Users groups have Manage Printers permission by default. When you set up options, log on using an account that has Manage Printers permission.

1 Click **[Start]** on the taskbar, point to **[Settings]**, and then click **[Printers]**.

The **[Printers]** window appears.

2 Click to select the icon of the printer you want to use.

3 On the **[File]** menu, click **[Properties]**.

The Printer Properties appear.

4 Click the **[Device Settings]** tab.

5 Select the options you have installed.

6 Click **[OK]**.

Windows NT 4.0 - Installing the PostScript Printer Driver

Installing the printer driver

Limitation

- Installing a printer driver requires Administrators permission. When you install a printer driver, log on using an account that has Administrators permission.

Important

- The CD-ROM containing the Windows NT Server operating system version 4.0, or the Windows NT Workstation operating system is required for installing the printer driver.
- We recommend that you upgrade the Windows NT 4.0 operating system to Service Pack 4 or later before installing the printer driver. Contact your Windows retailer for more information about the latest version available.

1 Close all applications that are running.

2 Insert the CD-ROM into the CD-ROM drive.

Auto Run will start the installer.

3 Select a language to change the interface language, and then click [OK].

The following languages are available: Cestina (Czech), Dansk (Danish), Deutsch (German), English (English), Espanol (Spanish), Francais (French), Italiano (Italian), Magyar (Hungarian), Nederlands (Dutch), Norsk (Norwegian), Polski (Polish), Portugues (Portuguese), Suomi (Finnish), Svenska (Swedish)

Default interface language is English.

Note

- The printer driver with the selected language will be installed.
- The printer driver will be installed in English if you select the following languages: Cestina, Magyar, Polski, Portugues and Suomi.

4 Select [PostScript 3 Printer Driver].

[Add Printer Wizard] starts.

5 Click [Next].

6 After confirming that the [My Computer] option is selected, click [Next].

A dialog box for selecting the printer port appears.

7 Select the check box of the port you want to use, and then click [Next].

A dialog box for selecting the printer appears.

8 Select the printer you want to use, and then click [Next].

9 Follow the instructions on the screen.

Setting up options

! Limitation

- ❑ Changing the printer settings requires Manage Printers permission. Members of the Administrators and Power Users groups have Manage Printers permission by default. When you set up options, log on using an account that has Manage Printers permission.

! Important

- ❑ If the printer is equipped with certain options, you should set up the options with the printer driver.

1 Click **[Start]** on the taskbar, point to **[Settings]**, and then click **[Printers]**.

The **[Printers]** window appears.

2 Click to select the icon of the printer you want to use.

3 On the **[File]** menu, click **[Properties]**.

The Printer Properties appear.

4 Click the **[Accessories]** tab.

5 Select options you have installed from the **[Options]** group.

6 Click **[OK]**.

💡 The conditions of the bidirectional transmissions

When bidirectional transmissions are enabled, the information about the paper size and feed direction settings are automatically sent to the machine by the computer. You can also check the machine's status from your computer.

- Bidirectional transmissions are supported by Windows 95/98/Me, Windows 2000 and Windows NT 4.0.
- When the bidirectional transmission is working, the machine status and information are obtained when opening the printer driver screen.

To support the bidirectional transmissions, the following conditions are required.

◆ When connecting with a parallel cable

- The computer must support the bidirectional transmissions.
- The Interface cable must support the bidirectional transmissions.
- The machine must be connected to the computer using the standard parallel cable and the parallel connector.
- On Windows 95/98/Me, **[Enable bi-directional support for this printer]** must be selected in **[Spool Settings...]** on the **[Details]** tab.

- On Windows 2000 and Windows NT 4.0, **[Enable bi-directional support]** must be selected and **[Enable printer spooling]** must not be selected on the **[port]** tab.

❖ When connecting with the network

- SmartNetMonitor for Admin or SmartNetMonitor for Client included on the CD-ROM must be installed, and the TCP/IP protocol must be used.

Using Adobe PageMaker Version 6.0 or 6.5

If you use the printer under Windows 95/98/Me, Windows 2000, Windows NT 4.0 with Adobe PageMaker, you need to copy the PPD file to the PageMaker folder.

The PPD file is the file with extension ".ppd". It is in the folder "DRIVERS\PS\WIN9X_ME\ (Language)\DISK1\" on the CD-ROM.

The **[WIN9X_ME]** folder, inside the **[PS]** folder is for the Windows 95/98/Me operating system. Use the folder at this level that is appropriate for the operating system you are using.

The third folder, "(Language)" may be substituted by an appropriate language name.

Copy this file to the PageMaker folder.

For PageMaker 6.0 default installation, the folder is "C:\PM6\RSRC\PPD4", and for PageMaker 6.5 default installation, the directory is "C:\PM65\RSRC\USENGLISH\PPD4". "USENGLISH" may differ depending on your language selection.

Reference

For more information about the language name, see p.38 "Quick Install".

Installing the SmartNetMonitor for Client/Admin

⚠ Limitation

- ❑ If your system is Windows 2000 or Windows NT 4.0, installing software by Auto Run requires Administrators permission. When you install a printer driver by Auto Run, log on using an account that has Administrators permission.

1 Close all applications that are running.

2 Insert the CD-ROM into the CD-ROM drive.

Auto Run will start the installer.

3 Select a language to change the interface language, and then click **[OK]**.

The following languages are available: Cestina (Czech), Dansk (Danish), Deutsch (German), English (English), Espanol (Spanish), Francais (French), Italiano (Italian), Magyar (Hungarian), Nederlands (Dutch), Norsk (Norwegian), Polski (Polish), Portugues (Portuguese), Suomi (Finnish), Svenska (Swedish)

Default interface language is English.

4 Select **[SmartNetMonitor for Client/Admin]**.

5 The software license agreement appears in the **[License Agreement]** dialog box.

After reading through all of the contents, click **[I accept the agreement]** to agree with the license agreement, and then click **[Next]**.

6 Select the program you want to install when the "Select Program" dialog box appears.

7 Follow the instructions on the screen.

Installing the Agfa Monotype Font Manager 2000

⚠ Limitation

- ❑ If your system is Windows 2000 or Windows NT 4.0, installing software by Auto Run requires Administrators permission. When you install a printer driver by Auto Run, log on using an account that has Administrators permission.

1 Close all applications that are running.

2 Insert the CD-ROM into the CD-ROM drive.

Auto Run will start the installer.

3 Select a language to change the interface language, and then click [OK].

The following languages are available: Cestina (Czech), Dansk (Danish), Deutsch (German), English (English), Espanol (Spanish), Francais (French), Italiano (Italian), Magyar (Hungarian), Nederlands (Dutch), Norsk (Norwegian), Polski (Polish), Portugues (Portuguese), Suomi (Finnish), Svenska (Swedish)

Default interface language is English.

4 Select [Agfa Monotype Font Manager 2000].

5 Follow the instructions on the screen.

Macintosh

Macintosh - Installing the PostScript 3 Printer Driver

It is necessary to install a printer driver and a PPD file to print from a Macintosh. Follow these steps to install a printer driver and a PPD file on Macintosh running the 8.6 operating system or later up to 9.1.

- 1** Insert the CD-ROM into the CD-ROM drive.
- 2** Double-click the CD-ROM icon.
- 3** Double-click the [PS DRIVER] folder.
- 4** Double-click the folder of the language you use.
- 5** Open [DISK1] and double-click the installer icon.
The PostScript 3 printer driver installer window appears.
- 6** Follow the instructions on the screen.
- 7** Double-click [Extensions] in [System Folder].
- 8** Double-click [Printer Descriptions].
- 9** Double-click the CD-ROM icon on the desktop.
- 10** Double-click [DISK1] in the folder of the language you use.
- 11** Drag the PPD file into [Printer Descriptions] in [Extensions] in [System Folder].
- 12** Drag the plugin file into [Printer Descriptions] in [Extensions] in [System Folder].
- 13** Restart the Macintosh.

Setting Up the PPD File

Preparation

Make sure that the machine is connected to an AppleTalk network before performing the following procedure.

- 1** On the [Apple] menu, select [Chooser].
- 2** Click the [Adobe PS] icon.
- 3** In the [Select a PostScript Printer:] list, click the name of the machine you want to use.

4 Click **[Setup]**.

5 Click the printer description file you want to use, and then click **[Select]**.

The PPD file is set up, and the **[Adobe PS]** icon appears at the left of the machine name in the list. Next, follow the procedure on p.53 “Setting Up Options” to make the option settings, or close the **[Chooser]** dialog box.

Setting Up Options

1 On the **[Apple]** menu, select **[Chooser]**.

2 Click the **[Adobe PS]** icon.

3 In the **[Select the PostScript Printer:]** list, click the name of the machine you want to use, and then click **[Setup]**.

4 Click **[Configure]**.

A list of options appears.

5 Select the option you want to set up and select the appropriate setting for it.

 **Note**

- If the option you want to set up is not displayed, the PPD file might not be set up correctly. Check the name of the PPD file shown in the dialog box.

6 Click **[OK]**.

The list of options closes.

7 Click **[OK]**.

The **[Chooser]** dialog box appears.

8 Close the **[Chooser]** dialog box.

 **Reference**

For information about installing the Printer Utility for Mac, see the PostScript 3 Operating Instructions Supplement.

INDEX

1394 Interface Unit Type 4510, 12, 22

A

Active Protocol, 31
Agfa Font Manager, 5, 51

B

Bridge Unit Type1045, 12
Bridge Unit Type460, 12
Bypass Tray, 7

C

Caution, ii
Control Panel, 6, 9

D

Data In Indicator, 9
development unit, 8
Duplex Unit, 7
Duplex Unit right cover, 7

E

Enter Key, 10
Error Indicator, 9
Escape Key, 10
Ethernet, 31
ethernet cable connector, 6

F

Finisher SR720, 12
Finisher SR730, 12
Form Feed Key, 9
Frame type NetWare, 31
front cover, 6
fusing unit, 8

G

Gateway Address, 31, 35

H

HDD (Option) Slot, 6

I

IP address, 31

J

Job Reset Key, 9

L

Large Capacity Tray RT36, 11
lower vertical paper feed cover, 7

M

Mailbox CS360, 12
Memory Unit TypeC, 12, 14
Menu Key, 9

N

Network, 31
Network Boot, 31
Network Printing Guide, v

O

On Line Key, 9
Options, 11
options, installing, 14
options, setting up
 Windows 2000, 46
 Windows 95/98/Me, 45
 Windows NT 4.0, 48
output tray, 6

P

PageMaker 6.0 or 6.5, 49
Panel Display, 9
Paper Bank, 6, 11, 15
paper tray, 6
parallel interface connector, 6
PCL 5e, 3, 40
PCL 6, 3, 40
PostScript, 4
 Windows 2000, installing, 45
 Windows 95/98/Me, installing, 44
 Windows NT 4.0, installing, 47
PostScript 3
 Macintosh, Install, 52
power cord, 7
Power Indicator, 9
power switch, 6
printer board, 6
printer driver, 3
Printer Hard Disk Type4510, 12, 18
Printer Reference, v
PS430, 6, 11, 15

Q

Quick Install, 38
Quick Installation Guide, v

R

right cover, 8
RPCS, 3, 42

S

screwdriver, 13
Setup Guide, v
SmartNetMonitor for Admin, 5, 50
SmartNetMonitor for Client, 5, 50
Subnet Mask, 31, 35

T

toner holder, 8
toner lock handle, 8
transfer unit, 8

U

upper vertical paper feed cover, 7

V

ventilator, 7

W

Warning, ii
Windows 2000
 PostScript, installing, 45
 setting up options, 46
Windows 95/98/Me
 PostScript, installing, 44
 setting up options, 45
Windows NT 4.0
 PostScript, installing, 47
 setting up options, 48

MEMO